

	I	dimensioni	spessore	volume	carico ammesso	peso	prezzo
	E	dimension	thickness	volume	admitted load	weight	price
	D	abmessungen	stärke	volumen	tragfähigkeit	gewicht	preis
	F	dimension	épaisseur	volume	charge admise	poids	prix
		cm	mm	m3	kg	kg	euro

## WG System

design Massimo Castagna 2023



<b>B1</b> 120 x 46 x h 16	10	0,21		38	
---------------------------	----	------	--	----	--



<b>B2</b> 120 x 60 x h 16	10	0,25		48	
---------------------------	----	------	--	----	--



<b>B3</b> 120 x 46 x h 30	10	0,40		41	
---------------------------	----	------	--	----	--



<b>B4</b> 120 x 60 x h 30	10	0,51		52	
---------------------------	----	------	--	----	--



<b>B5</b> 179 x 46 x h 16	10	0,30		60	
---------------------------	----	------	--	----	--



<b>B6</b> 179 x 60 x h 16	10	0,39		76	
---------------------------	----	------	--	----	--



<b>B7</b> 179 x 46 x h 30	10	0,56		66	
---------------------------	----	------	--	----	--



<b>B8</b> 179 x 60 x h 30	10	0,73		82	
---------------------------	----	------	--	----	--

**Sovraprezzo per n. 01 foro per passaggio cavi / surcharge for n. 01 cable ducting hole**  
**Aupreis für Nr. 01 Kabeldurchführung / supplément pour n. 01 trou passe-câble**











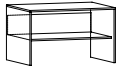

- Vetro extrachiaro / extra clear glass / extrahelles Glas / verre extra clair
- Vetro fumé / smoked glass / Rauchglas / verre fumé
- Vetro bronzo / bronze glass / Bronze Glas / Verre bronze

- Elementi a ponte, ad uso base o piano di appoggio, in vetro saldato extrachiaro, fumé o bronzo.  
 Fori passacavo a richiesta, indicare sempre la posizione.  
 - Bridge-like elements used as base or countertop, in glued extra clear, smoked or bronze glass.  
 On request cable ducting hole, always indicate position.  
 - Brückenformige Elemente zur Verwendung als Grundelement oder Ablage, aus verklebtem extrahellem Glas,  
 Rauchglas oder Bronze Glas. Auf Anfrage Kabeldurchführung, immer Position angeben.  
 - Eléments à pont à usage base ou plan d'appui, en verre collé extra clair, fumé ou bronze.  
 Sur demande trou passe-câble, indiquer toujours la position.

	I	dimensioni	spessore	volume	carico ammesso	peso	prezzo
	E	dimension	thickness	volume	admitted load	weight	price
	D	abmessungen	stärke	volumen	tragfähigkeit	gewicht	preis
	F	dimension	épaisseur	volume	charge admise	poids	prix
		cm	mm	m3	kg	kg	euro

## WG System

design Massimo Castagna 2023

<b>WG-61</b>		<b>P1</b> 61 x 46 x h 37	10	0,19	40	41	
		<b>P2</b> 61 x 60 x h 37	10	0,24	40	47	
		<b>P3</b> 61 x 46 x h 50	10	0,25	40	49	
		<b>P4</b> 64 x 60 x h 50	10	0,32	40	59	
<b>WG-120</b>		<b>P5</b> 120 x 46 x h 37	10	0,36	45	64	
		<b>P6</b> 120 x 60 x h 37	10	0,46	45	72	
		<b>P7</b> 120 x 46 x h 50	10	0,48	45	74	
		<b>P8</b> 120 x 60 x h 50	10	0,62	45	84	
<b>WG-179</b>		<b>P9</b> 179 x 46 x h 37	10	0,51	50	86	
		<b>P10</b> 179 x 60 x h 37	10	0,69	50	98	
		<b>P11</b> 179 x 46 x h 50	10	0,70	50	100	
		<b>P12</b> 179 x 60 x h 50	10	0,91	50	114	

**Sovrapprezzo per n. 01 foro per passaggio cavi / surcharge for no. 01 cable ducting hole**  
**Aupreis für Nr. 01 Kabeldurchführung / supplément pour n. 01 trou passe-câble**

- Vetro extrachiaro / extra clear glass / extrahelles Glas / verre extra clair
- Vetro fumé / smoked glass / Rauchglas / verre fumé
- Vetro bronzo / bronze glass / Bronze Glas / Verre bronze





- Sistema modulare di elementi in vetro saldato extrachiaro, fumé o bronzo con ripiano e schienale per alloggiare contenitori e optional in legno di pagina 155. Fori passacavo a richiesta, indicare sempre la posizione.  
- Modular system of elements in glued glass extra clear, smoked or bronze with shelf and back panel to accommodate wooden storage units and optional elements of page 155. On request cable ducting hole, always indicate position.  
- Modulares System aus verklebten Glaselementen in extrahell, Rauchglas oder Bronze mit Fach und Rückwand für Integrierung von Behältern und optionalen Elementen aus Holz siehe Seite 155. Auf Anfrage Kabeldurchführung, immer Position angeben.  
- Système modulaire de éléments en verre collé extra clair, fumé ou bronze avec étagère et dos pour accueillir contenueurs et optionnels en bois de la page 155. Sur demande trou passe-câble, indiquer toujours la position.

	I	dimensioni	spessore	volume	carico ammesso	peso	prezzo
	E	dimension	thickness	volume	admitted load	weight	price
	D	abmessungen	stärke	volumen	tragfähigkeit	gewicht	preis
	F	dimension	épaisseur	volume	charge admise	poids	prix
		cm	mm	m3	kg	kg	euro

## WG System

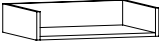
design Massimo Castagna 2023

OPTIONAL PER SISTEMA MODULARE DI PAG. 154  
 OPTIONALS FOR MODULAR SYSTEM OF PAGE 154  
 OPTIONALE ELEMENTE FÜR MODULARES SYSTEM AUF SEITE 154  
 OPTIONS POUR SYSTEM MODULAIRE DE LA PAGE 154

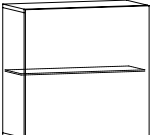
<b>EG1</b>		59 x 45 x h 13		0,06	10	7	
		Elemento a giorno / open element / offenes Element / élément ouvert					
<b>CB1</b>		59 x 45 x h 13		0,06	10	16	
		Cassetto / drawer / Schublade / tiroir					
<b>CA2</b>		59 x 45 x h 26		0,11	15	20	
		Cassettone /jumbo drawer /große Schublade / tiroir grande					
<b>ER1</b>		59 x 45 x h 26		0,11	15	13	
		Contenitore a ribalta / storage unit with flap door / Schließfach mit Klapptür / récipient avec porte à abattant					
<b>EB1</b>		60 x 30 x h 60		0,21	20	38	
		Contenitore battente in appoggio con ripiano interno in vetro countertop storage unit with hinge door and internal glass shelf auflegendes Schließfach mit Flügeltür und inneres Glasfach récipient en appui avec porte à battant et étagère en verre					

**Sovrapprezzo per n. 01 foro per passaggio cavi, completo di passacavo**  
**surcharge for no. 01 cable ducting hole, including cable duct**  
**Aufpreis für Nr. 01 Kabeldurchführung inkl. Lochdeckel**  
**supplément pour n. 01 trou passe-câble inclu couverture trou.**

**Specificare la finitura in legno dei contenitori e degli optional SIBERIAN ASH, EUCALIPTO o ROVERE NATURALE**  
**Specify wood finish of storage unit and optional elements SIBERIAN ASH, EUCALIPTO or NATURAL OAK**  
**Holzausführung der Behälter und optionalen Teile angeben SIBERIAN ASH, EUCALIPTO oder EICHE NATUR**  
**Indiquer finition bois des récipients et des éléments optionnels SIBERIAN ASH, EUCALIPTO ou ROUVRE NATUREL**

- Optional in legno Siberian Ash, Eucalipto o Rovere Naturale per elementi di pag. 154.  
Fori passacavo a richiesta, indicare sempre la posizione.
- Optional in wood Siberian Ash, Eucalipto or Natural Oak for elements of page 154.  
On request cable ducting hole, always indicate position.
- Optionale Elemente in Holz Siberian Ash, Eucalipto oder Natureiche für Element auf Seite 154.  
Auf Anfrage Kabeldurchführung, immer Position angeben.
- Optionnels en bois Siberian Ash, Eucalipto ou Rouvre Naturel pour les éléments de page 154.  
Sur demande trou passe-câble, toujours indiquer position.

<b>M1</b>		120 x 30 x h 5	4	0,06	40	30	
<b>M2</b>		180 x 30 x h 5	4	0,09	45	44	
<b>M3</b>		240 x 30 x h 5	4	0,12	50	60	

- Specchio / Mirror / Spiegel / Miroir
- Specchio fumè / Smoked mirror / Rauchglasspiegel / miroir fumé
- Specchio bronzo / Bronze mirror / Bronze Spiegel / Miroir bronze

- Mensole a parete rivestite in specchio, specchio fumè e specchio bronzo.
- Wall shelves covered in mirror, smoked mirror and bronze mirror.
- Wandkonsolen beschichte mit Spiegel, Rauchglasspiegel und Bronze Spiegel.
- Etagère au mur revêtu en miroir, miroir fumé et miroir bronze.

# WG System

design Massimo Castagna 2023

- Esempi di configurazione
- Composition examples
- Kompositionsbeispiele
- Exemples de composition

## WG-61

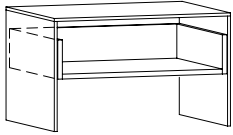

**S1**

61 x 46 x h 37  
P1+EG1

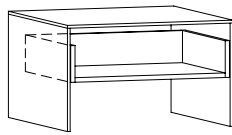

**S2**

61 x 60 x h 37  
P2+EG1

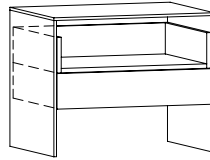

**S3**

61 x 46 x h 50  
P3+EG1+CB1

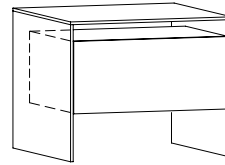

**S4**

61 x 60 x h 50  
P4+CA2

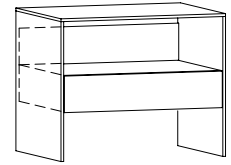

**S5**

61 x 46 x h 50  
P3+CB1

## WG-120

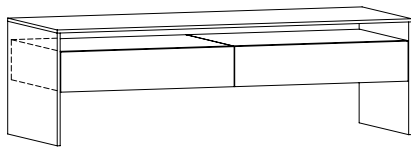

**S10**

120 x 46 x h 37  
P5+2 CB1

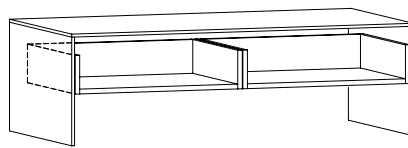

**S11**

120 x 60 x h 37  
P6+2 EG1

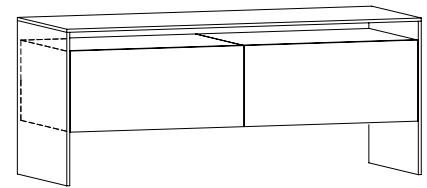

**S12**

120 x 46 x h 50  
P5+2 ER1

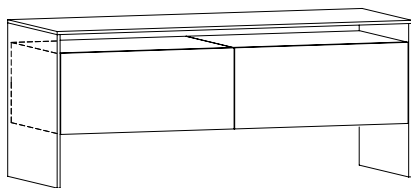

**S13**

120 x 46 x h 50  
P7+2 CA2

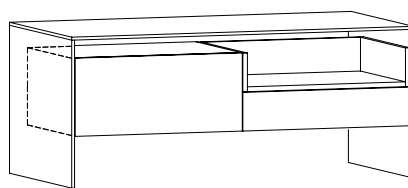

**S14**

120 x 60 x h 50  
P8+ER1+CB1+EG1

- Vetro extrachiaro / extra clear glass / extrahelles Glas / verre extra clair
- Vetro fumé / smoked glass / Rauchglas / verre fumé
- Vetro bronzo / bronze glass / Bronze Glas / Verre bronze

# WG System

design Massimo Castagna 2023

- Esempi di configurazione
- Composition examples
- Kompositionsbeispiele
- Exemples de composition

## WG-179

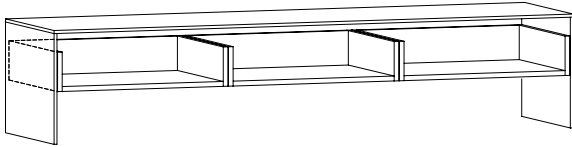

**S20**  
179 x 46 x h 37  
P9+3 EG1

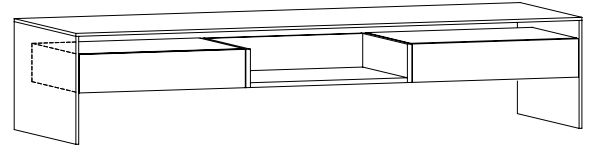

**S21**  
179 x 60 x h 37  
P10+EG1+2 CB1

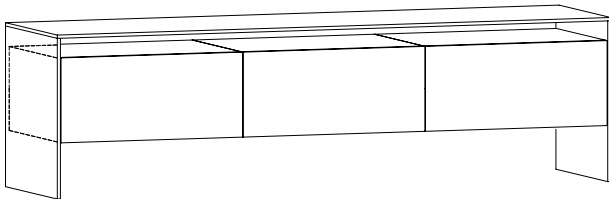

**S22**  
179 x 46 x h 50  
P11+3 CA2

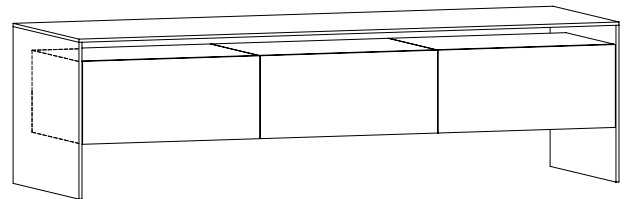

**S23**  
179 x 60 x h 50  
P12+3 ER1

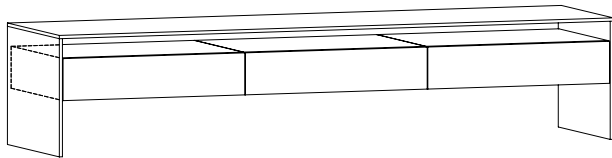

**S24**  
179 x 46 x h 37  
P9+3 CB1

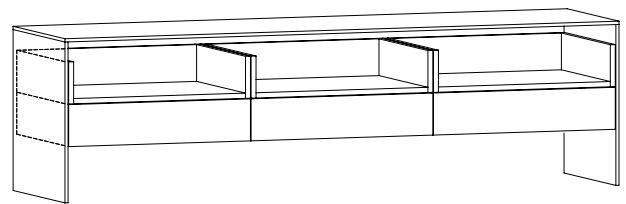

**S25**  
179 x 46 x h 50  
P11+3 CB1+3 EG1

- Vetro extrachiaro / extra clear glass / extrahelles Glas / verre extra clair
- Vetro fumé / smoked glass / Rauchglas / verre fumé
- Vetro bronzo / bronze glass / Bronze Glas / Verre bronze

# WG System

design Massimo Castagna 2023

## Composizioni / compositions / Kompositionen / compositions

### COMP 1

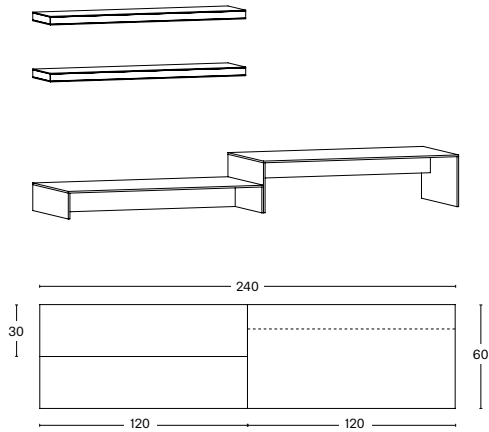

<b>2</b>	<b>M1</b>	120x30xH5			
<b>1</b>	<b>B2</b>	120x60xH16			
<b>1</b>	<b>B4</b>	120x60xH30			
TOTALE COMPOSIZIONE / TOTAL LAYOUT					

- Vetro extrachiaro / extra clear glass / extrahelles Glas / verre extra clair
- Vetro fumé / smoked glass / Rauchglas / verre fumé
- Vetro bronzo / bronze glass / Bronze Glas / Verre bronze

### COMP 2

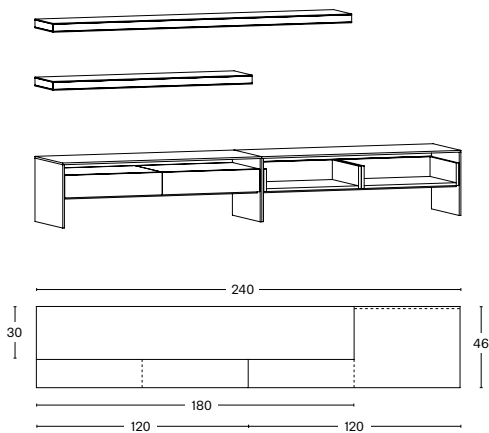

<b>1</b>	<b>M2</b>	180x30xH5			
<b>1</b>	<b>M1</b>	120x30xH5			
<b>1</b>	<b>P7</b>	120x46xH50			
<b>2</b>	<b>CB1</b>	59x45xH13			
<b>1</b>	<b>P7</b>	120x46xH50			
<b>2</b>	<b>EG1</b>	59x45xH13			
TOTALE COMPOSIZIONE / TOTAL LAYOUT					

- Vetro extrachiaro / extra clear glass / extrahelles Glas / verre extra clair
- Vetro fumé / smoked glass / Rauchglas / verre fumé
- Vetro bronzo / bronze glass / Bronze Glas / Verre bronze

### COMP 3

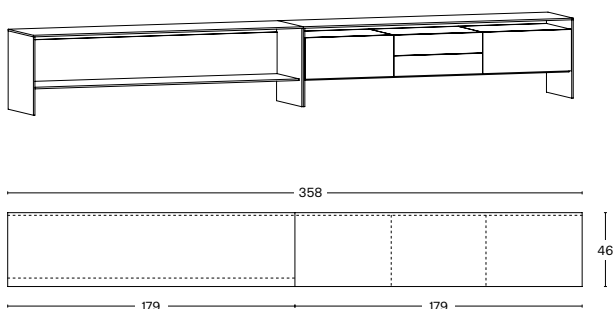

<b>1</b>	<b>P11</b>	179x46xH50			
<b>1</b>	<b>P11</b>	179x46xH50			
<b>2</b>	<b>ER1</b>	59x45xH26			
<b>2</b>	<b>CB1</b>	59x45xH13			
TOTALE COMPOSIZIONE / TOTAL LAYOUT					

- Vetro extrachiaro / extra clear glass / extrahelles Glas / verre extra clair
- Vetro fumé / smoked glass / Rauchglas / verre fumé
- Vetro bronzo / bronze glass / Bronze Glas / Verre bronze

# WG System

design Massimo Castagna 2023

## Composizioni / compositions / Kompositionen / compositions

### COMP 4

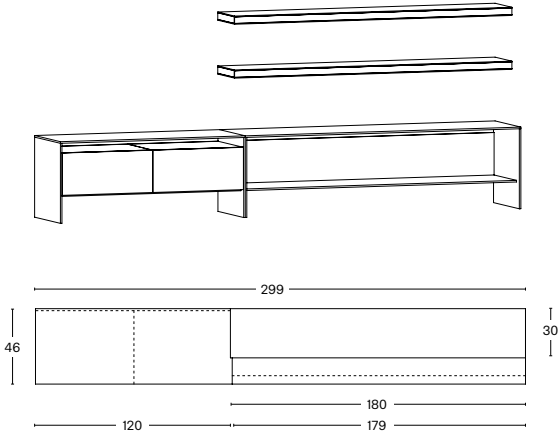

<b>2</b>	<b>M2</b>	180x30xH5		
<b>1</b>	<b>P7</b>	120x46xH50		
<b>2</b>	<b>ER1</b>	59x45xH26		
<b>1</b>	<b>P11</b>	179x46xH50		
TOTALE COMPOSIZIONE / TOTAL LAYOUT				

- Vetro extrachiaro / extra clear glass / extrahelles Glas / verre extra clair
- Vetro fumé / smoked glass / Rauchglas / verre fumé
- Vetro bronzo / bronze glass / Bronze Glas / Verre bronze

### COMP 5

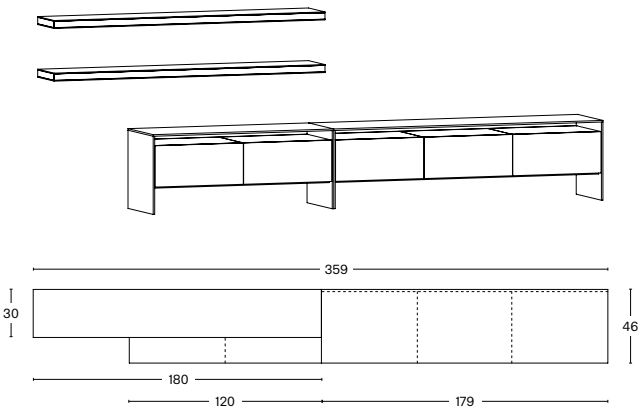

<b>2</b>	<b>M2</b>	180x30xH5		
<b>1</b>	<b>P7</b>	120x46xH50		
<b>2</b>	<b>CA2</b>	59x45xH26		
<b>1</b>	<b>P11</b>	179x46xH50		
<b>3</b>	<b>ER1</b>	59x45xH26		
TOTALE COMPOSIZIONE / TOTAL LAYOUT				

- Vetro extrachiaro / extra clear glass / extrahelles Glas / verre extra clair
- Vetro fumé / smoked glass / Rauchglas / verre fumé
- Vetro bronzo / bronze glass / Bronze Glas / Verre bronze

### COMP 6

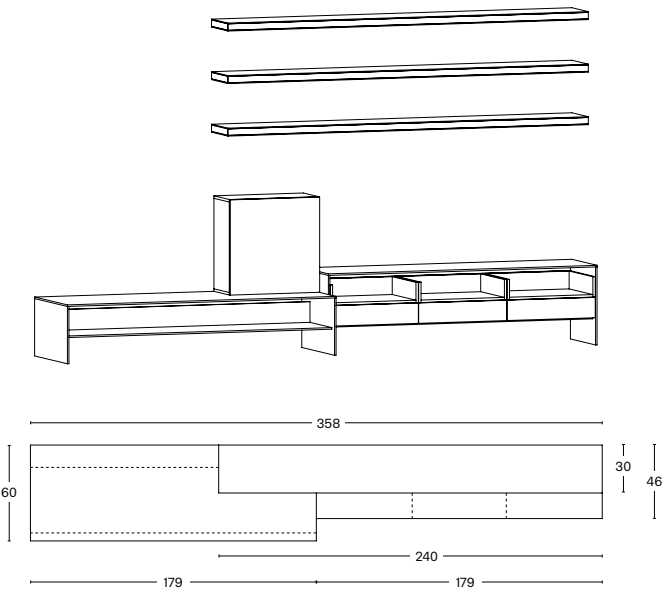

<b>3</b>	<b>M3</b>	240x30xH5		
<b>1</b>	<b>P10</b>	179x60xH37		
<b>1</b>	<b>P11</b>	179x46xH50		
<b>3</b>	<b>CB1</b>	59x45xH13		
<b>3</b>	<b>EG1</b>	59x45xH13		
<b>1</b>	<b>EB1</b>	60x30xH60		
TOTALE COMPOSIZIONE / TOTAL LAYOUT				

- Vetro extrachiaro / extra clear glass / extrahelles Glas / verre extra clair
- Vetro fumé / smoked glass / Rauchglas / verre fumé
- Vetro bronzo / bronze glass / Bronze Glas / Verre bronze